



## Protekt® Aire 9900

True Low Air Loss Mattress System with Alternating Pressure & Pulsation



## Instructions For Use

Streamline Medequip, LLC

5422 Kiam  
Houston, TX 77007

[www.stremlinmedequip.com](http://www.stremlinmedequip.com)  
346-445-4017

## **IMPORTANT SAFEGUARDS**

### **READ ALL INSTRUCTIONS BEFORE OPERATING THIS DEVICE**

The system has been designed to comply with regulatory safety standards including:

ANSI/AAMI ES60601-1

ANSI/AAMI 60601-1-2



#### **NOTE, CAUTION AND WARNING STATEMENTS:**

**NOTE**—Indicate some tips.

**CAUTION**—Indicate correct operating or maintenance procedures in order to prevent damage to or destruction of the equipment or other property.

**WARNING**—Call attention to a potential danger that requires correct procedures or practices in order to prevent personal injury.



#### **WARNING:** To reduce the risk of electrocution:

1. Patients are not allowed to operate the product. Always unplug this product immediately while it's not in use.
2. Do not disassemble the pump to avoid electrocution.
3. Do not place or store product where it can fall or be pulled into a tub or sink.
4. Do not place in or drop into water or other liquid. Do not use while bathing.
5. Do not reach for a product that has fallen into water. Unplug immediately.



#### **WARNING:** To reduce the risk of burns, electrocution, fire or injury to person:

1. The system must be operated with the mattress connected to the pump. Please do not power-off or unplug the pump while in use.
2. Always use the same voltage as stated on the label. Do not use other power cords on the pump. Keep the plastic packing away from children and pets to prevent suffocation hazards.
3. Equipment is not suitable to use in the presence of a flammable anesthetic mixture with air, with oxygen, or nitrous oxide.
4. Keep away from sharp objects.
5. Close supervision is necessary when this product is used by, on, or near children or people with disabilities.
6. Use this product only for its intended use as described in this manual. Do not use attachments not recommended by the manufacturer.
7. Never operate this product if the pump has a damaged power cord or plug, if the pump is not working properly, if the pump has been dropped or damaged, or the

pump has been dropped into water. Return the product to a service center or to the distributor for examination and repair.

8. Keep the power cord away from heated surfaces.
9. Never block the air openings of this product or place the product on a soft surface, such as a bed or couch, where the openings may be blocked. Keep the air opening free of lint, hair, and other similar particles.
10. Never drop or insert any object into any air opening or hose tube.
11. Avoid dropping or putting any heavy object on the pump.
12. Place the power cord and hose tube at patient's foot area to avoid strangling of patient's neck.
13. The pump will have minor heat generated in operation, please do not directly contact the surface continuously for more than 1 minute.
14. When the main supply is lost or has temporarily failed, the pump will stop, and the power failure alarm will alarm up to 20 minutes. This is normal and the product will return to normal operation once the main supply is resumed.
15. Do not modify this equipment without authorization of the manufacturer.
16. The device incorporates electronic programmable systems. Do not attempt to access the systems without authorization.



















**WARNING:** If the patient has a small body size and the side rails are lifted, ensure the openings through the side rails or the openings between the side rails and the mattress do not pose a threat to the patient. Frequently check patient against entrapment is required.



**CAUTION:** Any serious incident that has occurred in relation to the device should be reported to the manufacturer and the competent authority of the Member State in which the user and/or patient is established.

**PRODUCT SYMBOL DESCRIPTION**

I	POWER ON	O	POWER OFF
	ATTENTION		CAUTION, READ THE INSTRUCTIONS BEFORE USE
	AWAY FROM THE FLAME	IP21	WATER AND DUST PROTECTION CLASSIFICATION
	“BF” SYMBOL, INDICATES THIS PRODUCT IS ACCORDING TO THE DEGREE OF PROTECTION AGAINST ELECTRIC SHOCK FOR TYPE BF EQUIPMENT. APPLIED PART: MATTRESS		DISPOSAL OF ELECTRICAL & ELECTRONIC EQUIPMENT (WEEE): THIS PRODUCT SHOULD BE HANDED OVER TO AN APPLICABLE COLLECTION POINT FOR THE RECYCLING OF ELECTRICAL AND ELECTRONIC EQUIPMENT.
	DOUBLE INSULATED		MODEL NUMBER
	FUSE SPECIFICATION		CATALOGUE NUMBER
	HUMIDITY LIMITATION		BATCH CODE
	TEMPERATURE LIMIT		SERIAL NUMBER
	USE NO HAND HOOKS		UNIQUE DEVICE IDENTIFIER
	MANUFACTURER		
	SGS CERTIFICATION LOGO WITH RESPECT TO ELECTRICAL SHOCK, FIRE AND MECHANICAL HAZARDS ONLY IN ACCORDANCE WITH IEC 60601-1.		

## Contents

1.	INTRODUCTION .....	5
2.	INTENDED USE .....	5
3.	PRODUCT DESCRIPTION .....	5
4.	PRODUCT INSTALLATION GUIDE .....	6
5.	PANEL DISPLAY AND OPERATION GUIDE .....	9
6.	CLEANING .....	16
7.	STORAGE .....	17
8.	MAINTENANCE .....	17
9.	THE DISPOSAL OF AIR MATTRESS .....	18
10.	TROUBLESHOOTING.....	19
11.	TECHNICAL DATA.....	20

## 1. INTRODUCTION

This Instruction for use provides the information required for the initial set up and for the normal operation of the **Proactive Medical Product's Protekt® Aire 9900 Mattress System**. Before operating the **Proactive Medical Product's Protekt® Aire 9900 Mattress System**, be sure the operator has read and understood in detail the content of this Instruction for Use.

## 2. INTENDED USE

The **Proactive Medical Product's Protekt® Aire 9900 Mattress System** is intended for prevention of pressure ulcers. The **Proactive Medical Product's Protekt® Aire 9900 Mattress System** may be used in a variety of settings including, but not limited to individual home care setting and long-term care patients suffering from pressure ulcers, or pain management as prescribed by physician.

Contraindication—The mattress is not suitable for use on patients with unstable fractures.

The connection of the Fowler's Position Detector to the pump shall be performed by the operator. It's not designed for the patient to perform the connection.



**NOTE:** Equipment is not suitable for use in the presence of a flammable anesthetic mixture with air or with oxygen or nitrous oxide.

## 3. PRODUCT DESCRIPTION

The **Proactive Medical Product's Protekt® Aire 9900 Mattress System** is an alternating pressure air mattress replacement system used for the prevention of pressure ulcers by using the established principles of alternating therapy.

The control unit of the **Proactive Medical Product's Protekt® Aire 9900 Mattress System** is a pump featuring a digital pressure adjustment function, mode selections, and audiovisual alarms. The 18 air cells mattress unit alternates with 3 static head cells which remain static and provide a "pillow" support for optimum comfort. The mattress has a heavy-duty polyester-PU base sheet with a vapor permeable PU coated nylon quilted cover.

The system includes a rapid release twist CPR valve by the head section of the mattress in the event of cardiac arrest.

#### 4. PRODUCT INSTALLATION GUIDE

1. Unpack the box to inspect all items for any damage that may have occurred during shipping. If there is any damage, please contact your dealer immediately for assistance.
2. Place the mattress on top of the bed frame. The feet symbol on both sides of the mattress indicates location of the foot end.

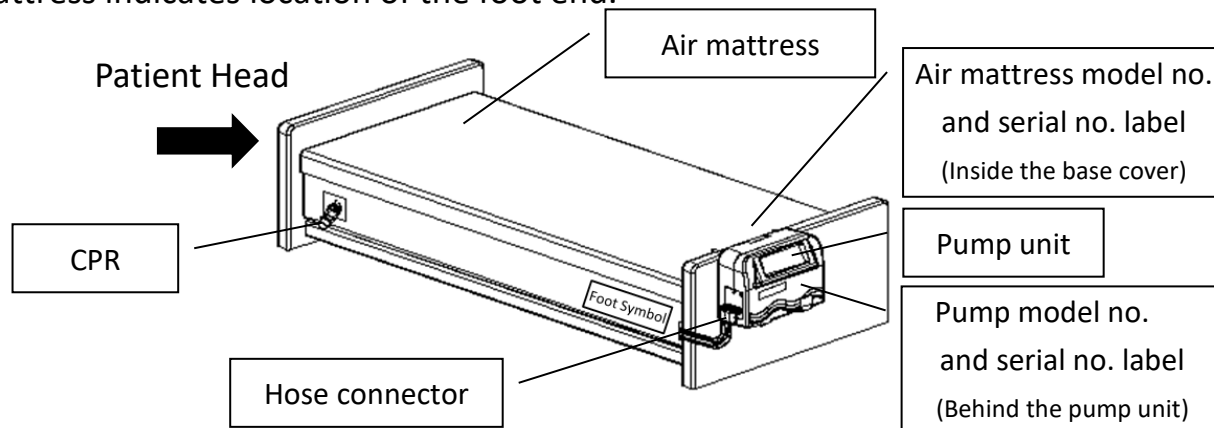

3. Secure the mattress onto the bed frame by using the securing side straps.

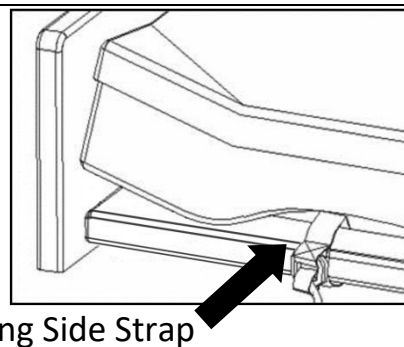

4. Ensure the CPR valve is at CLOSE position before turning on the power.

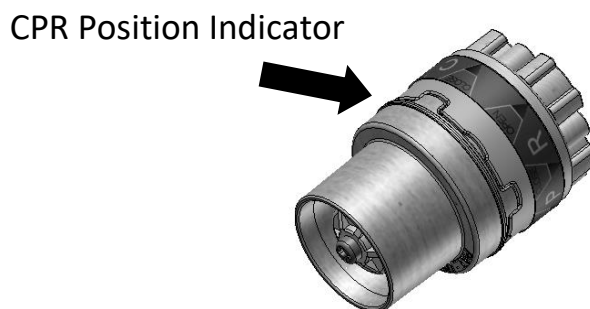

5. Position the pump by its elastic hanger brackets over footboard of the bed. The elastic hanger brackets will self-adjust onto the footboard tightly.
6. Remove the Transport Cap of the hose connector and connect the hose connector to the pump unit. Firmly push the hose connector into position and a “click” sound will secure the connection.
7. Connect the Fowler’s Position Detector cable to the pump unit by pushing in to secure the connection.

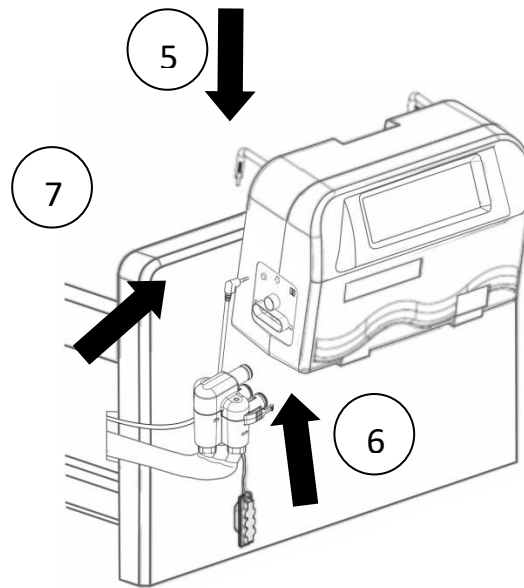

Follow the direction for connection.

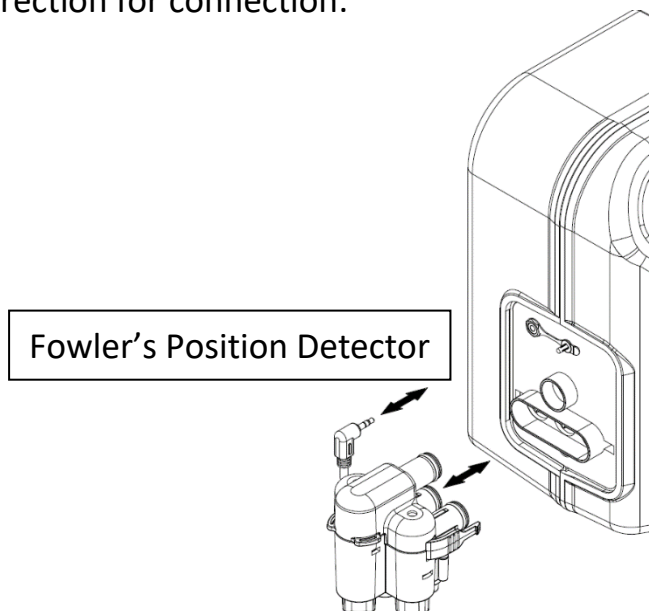

8. Connect the power cord to the pump. The power switch should remain off.
  9. Press the red power cord protector downward to secure the power cord.
  10. Plug the power cord into the electrical outlet.
- ⚠ **NOTE:** Check and ensure the pump unit is suitable for the local power voltage.
- ⚠ **CAUTION:** The pump can only be

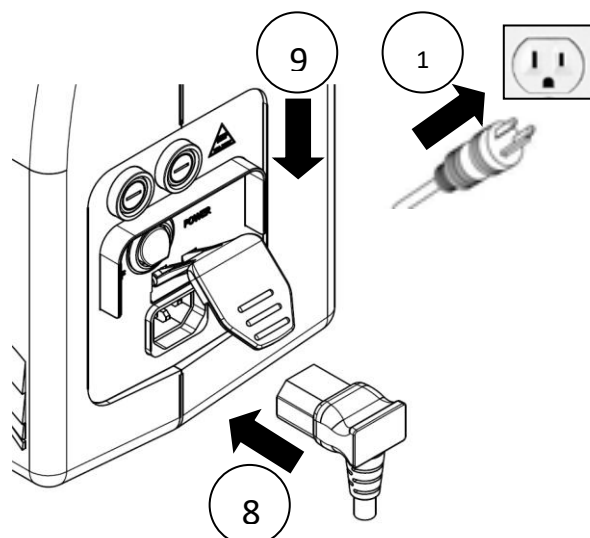



applied to the mattress recommended by the manufacturer. Do not use the pump for any other purpose.

⚠ **WARNING:** Do not place the pump unit in area where power cord can come off easily or inaccessible.

11. For patient's transportation, press "Auto-Firm" button and wait for 5 minutes for the mattress to be inflated. Disconnect the hose from the pump unit and put on the hose connector Transport Cap to keep the mattress inflated.

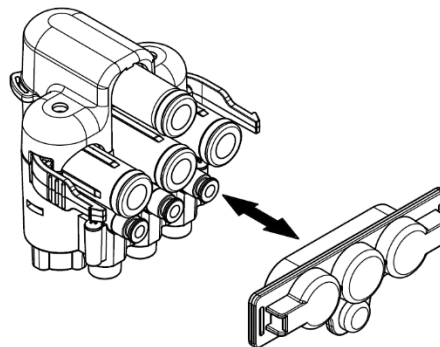

Bi-directional Transport Cap

## 5. PANEL DISPLAY AND OPERATION GUIDE

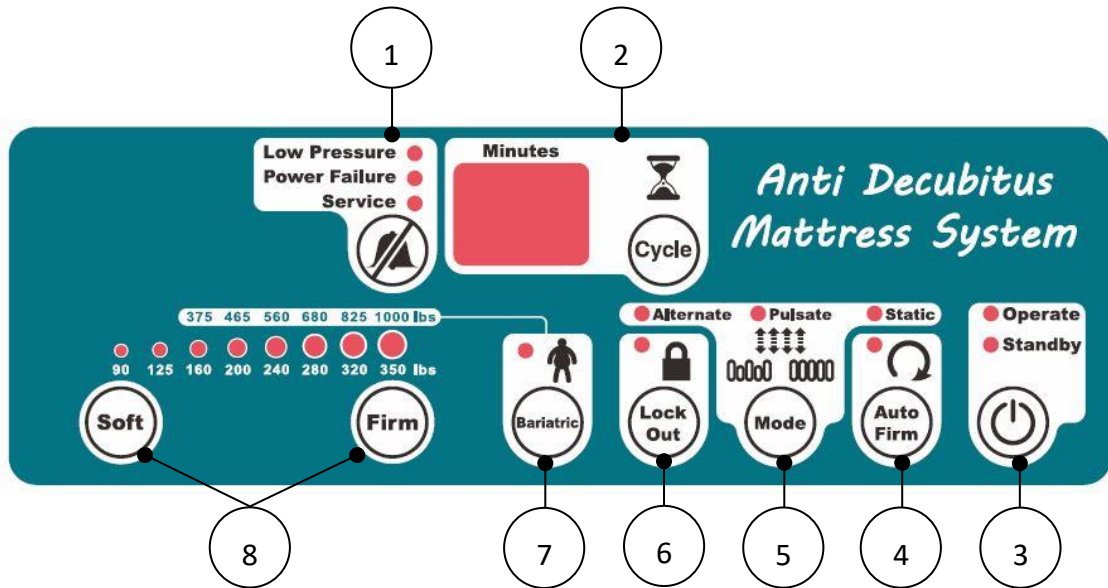

### 5.1 PANEL DISPLAY

- ① Alarm Mute and Alarm Indicator
  - Low Pressure Alarm Indicator
  - Power Failure Alarm Indicator
  - Service (Malfunction) Alarm Indicator
- ② Alternate/Pulsate Cycle Time Selection or Warning Code Display
- ③ Operating or Standby
- ④ Auto-Firm
- ⑤ Mode Selection (Alternate/Pulsate/Static)
- ⑥ Panel Lock-Out
- ⑦ Bariatric Mode
- ⑧ Comfort Control

#### 5.1.1 Alarm Mute

Press the alarm mute button to suspend temporary alarms. Should the situation not be resolved, and faulty conditions continue, the alarm will resume notifying the patient and caregiver.

#### 5.1.2 Alternate/Pulsate Cycle Time Selection

Alternate cycle time can be selected to 5, 10, 15, 20, 25, or 30 minutes by pressing the Cycle button.

Pulsate cycle time can be selected from 1-20 minutes by pressing the Cycle button.



### 5.1.3 Operate or Standby

Press this button to start operating or go into standby.



### 5.1.4 Auto-Firm

The pump will go into the inflation mode (LED lights flashing) every time the operate mode is triggered. This ensures the mattress to be able to reach its maximum operating pressure. Once the max pressure level is reached, the pump will automatically switch into the previous selected mode and comfort level. User can also use this function as full mattress inflation during patient sit-up or ingress/egress for better support.



### 5.1.5 Mode Selection

- Alternate—The air cells of the mattress are proportionally deflated to reduce the interface pressure. The alternating cycle will continue at the selected cycle time until another mode is selected.
- Static—The mattress maintains a constant lower pressure.
- Pulsate—The mattress maintains in static mode and oscillates at selected pressure at the selected cycle time. The pulsate cycle will continue until another mode is selected.

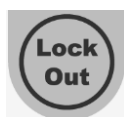

### 5.1.6 Panel Lock-Out

Press the Lock-Out button to lock the panel. Should the panel remain untouched for 30 seconds, the Lock-Out feature will lock the panel to prevent accident from changing setting without notice. To unlock, press the Lock-Out button for 3 seconds.



### 5.1.7 Bariatric Mode

Bariatric mode enhances the output of the pump for heavier patient support. Refer to **Table 1 Weight and Comfort Level Reference** for weight and comfort level

recommendation.



### 5.1.8 Comfort Control

Comfort controls the air pressure output level. Press Firm button and the output pressure will increase and higher pressure output will support heavier weight patient, for decreasing air pressure, vice versa. Check to see if the suitable pressure is selected by sliding one hand between a deflated air cell and the patient's buttocks areas and there should be minimum contact. Always leave at least 1 inch space between a deflated air cell and patient's buttocks areas to prevent "bottoming-out". Refer to **Table 1 Weight and Comfort Level Reference** for weight and comfort level suggestion.

## 5.2 OPERATION GUIDE

### 5.2.1 General Operation:



**NOTE:**  The power switch is located on the side of the pump.



- Press  to turn on the unit, all LED indicators on the control panel will light up accompanied with a beep for 2 seconds (check for indicator failure if any), and the indicator of Standby on the control panel will light up. If the pump was previously shut off in operate mode, then the pump will enter operate mode directly.

To test the battery, press  to turn off the power and the power failure alarm should be triggered. Refer to **5.2.3 Audiovisual Alarm** if the alarm is not triggered.

- Press the Operate button  and the system will begin to inflate, and the "Auto-Firm" indicator will be flashing.
- The mattress should be fully inflated within 5 minutes, and automatically enter the previous operating mode, otherwise the low pressure alarm with warning code "iE" will be triggered.







**NOTE:** Do not proceed to other settings before inflation is completed.

- After initial inflation is completed. Press Auto-Firm button  for moving the patient onto the mattress. The mattress will turn into a steady condition in approx. 5 minutes. Move the patient onto the mattress and press Auto-Firm button  again to cancel Auto-Firm mode and select the appropriate mode.

- According to the weight of the patient, adjust the pressure setting to the most suitable level without “bottoming-out”. User can determine an appropriate pressure by adjusting the Comfort Level. Please consult with your physician for a proper setting.

 **WARNING:** The pump unit should always be operating to prevent pressure injury from occurring.

- In operate mode, press operate/standby button  for the system to enter standby mode. The system should be in standby mode before shut down. Switch the power switch  to off and the warning code “S.d” will appear on the display to shut off the system.

 **NOTE:** For reminder purposes, power failure alarm will be triggered if the power is switched off in operating mode (refer to **5.2.3 Audiovisual Alarm**). Press power switch  to restart the system, or press Alarm Mute  to turn off the system (refer to **5.2.4 Alarm Mute**)

**Table 1 Weight and Comfort Level Reference**

Body shape	BARIATRIC Indicator	Comfort Control Indicator	Patient Weight									
			88	132	176	220	264	308	352	396	(LBS)	
			40	60	80	100	120	140	160	180	(KG)	
Standard												
Bariatric												

Protekt® Aire 9900 & 81090-36

Body shape	BARIATRIC Indicator	Comfort Control Indicator	Patient Weight								
			88	132	176	220	264	308	352	396	(LBS)
			40	60	80	100	120	140	160	180	(KG)
Standard	●	●●●●●●●●	■	■							
	●	●●●●●●●●	■	■	■						
	●	●●●●●●●●		■	■	■					
	●	●●●●●●●●			■	■	■				
	●	●●●●●●●●				■	■	■			
	●	●●●●●●●●					■	■	■		
	●	●●●●●●●●						■	■	■	
Bariatric	●	●●●●●●●●	■	■							
	●	●●●●●●●●	■	■	■						
	●	●●●●●●●●		■	■	■					
	●	●●●●●●●●			■	■	■				
	●	●●●●●●●●				■	■	■			
	●	●●●●●●●●					■	■	■		
	●	●●●●●●●●						■	■	■	

**Protekt® Aire 9900 & 81090-42, 81090-48, 81090-54, 81090-60**

**5.2.2 CPR**

When CPR needs to be performed, quickly rotate the CPR valve to “OPEN” position, at the same time, disconnect the hose connector from the pump to speed up the air release.

**5.2.3 Audiovisual Alarm**

- Power Failure—When electrical shortage occurs or power cord is unplug without turning off the pump or  is pressed (intentionally or unintentionally), the “Power Failure” indicator will light up along with buzzer and will last 20 minutes.



**NOTE:** When the pump has not been used for more than 3 months or after the Power Failure Alarm has been buzzing for a long time and  is showing after the pump has been restarted, the pump may need 6 hours or more of charging time (in operate or standby mode) for the alarms to function properly.

- Low Pressure—When an abnormal low pressure occurs in the body section, the "Low Pressure" indicator will flash and beep. Should the situation not be resolved, and faulty conditions continue, the alarm will resume.
- Service (Malfunction)—When faulty conditions occur, the "Service" indicator will light up along with buzzer.



**NOTE:** Refer to **Table 2 for Warning Code Reference** if error code appears on the display or refer to **10. TROUBLESHOOTING**

#### 5.2.4 Alarm Mute

- When alarms are triggered, both LED light and buzzer will turn on to warn the patient and caregiver. By pressing the button, it will temporarily mute the buzzer so the caregiver may check for possible causes. Should the situation not resolve and faulty conditions continue, the alarm will resume. Refer to **10. TROUBLESHOOTING** for diagnosis.
- During “power failure”, pressing “alarm mute” will cease all buzzers and indicators and turn off the system.
- During “low pressure alarm” if the pressure resumes back to normal, then the low pressure alarm will stop.
- When more than one alarm is triggered, the alarm will be performed according to priority level. Refer to **Table 2 Warning Code Reference** for priority level.

**Table 2 Warning Code Reference**

PRIORITY HIGH ↓ LOW	WARNING CODE	INDICATOR LED	AUDIBLE OUTPUT MODE	WARNING DESCRIPTION	REMARKS
0	N/A	N/A	ONCE	Key Tone from Functional Buttons	Key Tone
1		Power Failure	ONCE	Shutdown	Shutdown
2		ALL LED	ONCE	All Indicators On	Power-On
3	N/A	N/A	ONCE	No Display	State/Mode Switching
4		Auto-Firm	ONCE	Inflation Ended	Mattress Inflation Completion
5		Auto-Firm	ONCE	Auto-Firm Ended	Auto-Firm Completion
6		Static	ONCE	Static Ended	Static Completion
7	N/A	Power Failure	REPEAT (Cycle 4 sec.)	No Display	Power Failure Alarm
8		Low Pressure	REPEAT (Cycle 4 sec.)	Inflation Failure	Power-On Inflation Failure Alarm
9		Low Pressure	REPEAT (Cycle 4 sec.)	Auto-Firm Failure	Auto-Firm Failure Alarm
10		Low Pressure	REPEAT (Cycle 4 sec.)	Low Pressure	Low Pressure Overtime Alarm
11		Service	REPEAT (Cycle 4.5 sec.)	High Pressure	High Pressure Overtime Alarm
12		Service	REPEAT (Cycle 4.5 sec.)	High Temperature	High Ambient Temperature Alarm
13		Service	REPEAT (Cycle 4.5 sec.)	Air Valve 1 Failure	Air Valve 1 Positioning Failure Alarm
14		Service	REPEAT (Cycle 15 sec.)	Low Battery	Low Battery Alarm
15		NONE	NONE	Lift-Up High	Lift-Up Angle > 45° (± 15°)
16		NONE	NONE	Lift-Up Low	Lift-Up Angle > 20° (± 15°)
17		Service	REPEAT	Service Indicator	
18		NONE	NONE	Calibration Uncompleted	Calibration Uncompleted
19		NONE	NONE	Calibration Completed	Calibration Completed

### 5.2.5 Fowler's Position Detector

- Fowler's Position Mode will be triggered, and output pressure will increase when the upper half of the mattress is elevated and exceeds an angle of 20° (± 15°) or more, and the warning code will appear on the display. The pump unit will resume to previous setting when it is lower than an angle of 20° (± 15°).
- Auto-Firm mode will be activated when the upper half of the mattress is elevated and exceeds an angle of 45° (± 15°) or more, and the warning code will appear on the display. The pump unit will resume to previous setting when it's lower than an angle of 45° (± 15°).



## 6. CLEANING

Wipe the pump unit with a damp cloth pre-soaked with a mild detergent and keep the pump unit away from dust. If other detergent is used, choose one that will have no chemical effects on the surface of the plastic case of the pump unit.



**CAUTION:** Do not immerse or soak the pump unit.

Clean the mattress cover by using single use wipes with a solution of neutral detergent and hand hot water. Rinse thoroughly with clean water and damp dry the mattress using single use wipes. When cleaning, always visually check the mattress for cuts, tears, cracks, pin holes or snags. Do NOT use a mattress with a damaged cover – If the inner core of the mattress is heavily soiled, you are advised to replace it.

### Disinfecting the cover

If the cover is heavily soiled or has been exposed to bodily fluids such as blood, it will require a more thorough cleaning procedure.

Use single use wipes with a 0.1 % chlorine solution (1,000 ppm) and cold water to wipe the cover. Rinse thoroughly with clean water and damp dry the mattress using single use wipes. Ensure the cover is completely dried before refitting to the mattress.

Frequent or prolonged exposure to higher concentration disinfectant solutions may prematurely age the fabric cover of mattresses. Cover surfaces should be protected during use and rinsed and dried thoroughly after disinfectant.

### Laundering

- Before laundering, mattress cover should be completely removed.
- Remove the Fowler's Position Detector located underneath the mattress bottom before laundering.
- Mattress covers can be laundered as follows:
  - Prewash 60 °C + 15 minutes
  - Main wash 60 °C + 15 minutes
  - This should be followed by a cold rinse and extraction.
  - Fowler's Position Detector is not washable. It can be wiped as described and installed back after the mattress is completely dry.

### Drying

Mattress covers should be hung from a line or bar and drip dried in a clean indoor environment. Covers must be completely dried before refitting to the mattress.

Mattress covers can be tumble dried on a low heat setting for 90 minutes. Drying temperature must not exceed 40 °C. Exceeding the temperature can cause significant

damage to the mattress cover.



**CAUTION:** Do not use phenolic-based product for cleaning.



**CAUTION:** After cleaning, dry the mattress without direct exposure of sunlight.

## 7. STORAGE

- Rotate the CPR valve to OPEN position and disconnect the hose connector to release the air.
- Lay the mattress flat and roll the mattress from the head end towards the foot end.
- Tighten the packing strap around the rolled mattress to prevent unrolling.
- Ensure the hose connector is wrapped around the mattress to prevent kinking the hose connector.

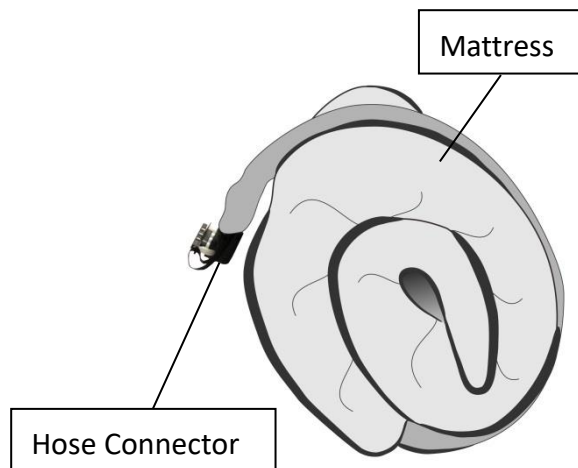

- The pump power cord can be coiled around the pump or disconnected for storage.

## 8. MAINTENANCE



**WARNING:** Maintenance shall only be performed when the device is not in use.

### General

- Check main power cord and plug if there are abrasions or excessive wear.
- Check mattress cover for signs of wear or damage. Ensure mattress cover and tubes are secured together correctly.
- Check the air hoses for any kink or break. For replacement, please contact your local dealer.

### Fuse replacement

- Disconnect the plug from main power when a blown fuse is suspected.
- Remove the cover of the fuse holder by means of a small screwdriver.

- Insert a new fuse in the correct rating and replace the cover of the fuse holder. The fuse rating should comply with the requested specification.

### **Air Filter Replacement**

After checking **10. TROUBLESHOOTING**, if the air filter needs to be replaced:

- Replace the air filter located at the back of the pump.
- The filter is reusable and can be washed gently with a mild detergent and water. Dry the filter before use.
- Check and replace air filter regularly if environment is dirty.

## **9. THE DISPOSAL OF AIR MATTRESS**

When the air mattress is broken or no longer useable, the mattress and the pump may be discarded for recycle.

## 10. TROUBLESHOOTING

PROBLEM	SOLUTION
The mattress is not able to connect with the pump	<ul style="list-style-type: none"> <li>● Check if the mattress model (model no. located inside the cover by the foot end) xxAAAxix matches with the pump model xxBBB-xxx. The AAA should be the same as BBB. If not, please contact with the agent or distributor.</li> <li>● Check if the Transport Cap is removed and make sure the connector is not broken.</li> </ul>
The pump is showing no indications of working	<ul style="list-style-type: none"> <li>● Check if the plug is connected to the main supply.</li> <li>● Check if the power switch is switched to ON position (press ).</li> <li>● Check if there is any blown fuse.</li> </ul>
Power failure alarm failed	<ul style="list-style-type: none"> <li>● If the pump is in operation but failed to trigger the power failure alarm during power off - Charge the pump for 6 hours or more of operating time. If the power failure still does not work, then please contact the dealer or agent for further investigation.</li> </ul>
The low pressure light is constantly flashing and the alarm is sounded	<ul style="list-style-type: none"> <li>● Check if the CPR is at the CLOSE position</li> <li>● Check if the connection between air tubes to pump unit is tightly secured.</li> <li>● Check if all coupling connections along mattress are secured.</li> <li>● If the main supply is normal but there is no sound of the pump, please remove the connector from the pump to check if there's air comes out. If not, please turn off the machine and contact the dealer or agent for further investigation.</li> <li>● If all of above steps have been checked. Press "Alarm Mute" for system to be verified again.</li> </ul>
The pump is on, but the mattress is not alternating	<ul style="list-style-type: none"> <li>● Ensure the mattress inflation is completed.</li> <li>● Check the pump control panel - the indicator of "Alternate" should be lighted on, if not, switch it to "Alternate."</li> <li>● Check if "Service" alarm indicator is on with buzzer, if yes, contact the dealer or agent for further investigation.</li> </ul>
Service (Malfunction) Alarm is on	<ul style="list-style-type: none"> <li>● Press "alarm mute" for system to be verified again. If the alarm is still on, please contact dealer or agent.</li> </ul>
The pump is operating noisily	<ul style="list-style-type: none"> <li>● Make sure the pump is resting against a solid surface.</li> <li>● If the noise gets louder, contact the dealer or agent for further investigation.</li> </ul>
Patient is bottoming out (without alarm triggered)	<ul style="list-style-type: none"> <li>● Pressure setting might be inadequate for the patient, adjust comfort level to FIRM (refer to <b>Table 1 Weight and Comfort Level Reference Table</b>) and wait for a few minutes for better comfort.</li> <li>● Follow the procedures "The low pressure light is constantly flashing and the alarm is sounded" for inspection.</li> </ul>

If the above information does not solve the problem, please contact your local dealer or agent for further support.

## 11. TECHNICAL DATA

### 11.1 PRODUCT SPECIFICATION

PUMP UNIT		AIR MATTRESS	
Model	81090	Model	8" Mattress
Dimension (cm)	40 (W) x 17.5 (D) x 27.5 (H)	Dimension (cm)	200 (L) x 90 (W) x 20(H) 200 (L) x 107 (W) x 20 (H) 200 (L) x 122 (W) x 20 (H) 200 (L) x 137 (W) x 20 (H) 200 (L) x 153 (W) x 20 (H)
Weight (kg)	6.5	Weight (kg)	7.0 (81090-36) 7.4 (81090-42) 7.9 (81090-48) 8.4 (81090-54) 9.0 (81090-60)
Alternate Cycle Time (minutes)	5/10/15/20/25/30	Air Cell Material	Nylon-TPU
Pulsate Cycle Time (minutes)	1 to 20	No. of Air Cells	18 Cells
Auto-Firm Time (minutes)	20	Cover Material	Nylon-PU with Quilt
Pump Output Flowrate (LPM)	> 1000 (230 V) Note: The flow rate may be varied due to the fluctuation of input voltage.	Bottom Material	Polyester-PU
		Standard Max. Weight (kg)	350 lbs.
Pump Output Pressure Range (mmHg)	20 to 46 (± 5)	Bariatric Max. Weight (kg)	1000 lbs.
Input Voltage	AC 120 V/60 Hz		
Input Current	4.8 A <sub>MAX</sub> (@132 V <sup>~</sup> )		
Fuse Rating	T5AL 250 VAC		
Frequency	60 Hz (120 V)		
Degree of Protection Against Electric Shock	Class II		
	Type BF 		
Warranty	2 years	Warranty	2 years
ENVIRONMENTAL CONDITIONS			
Operating Conditions		+ 5 °C to + 35 °C at a relative humidity range of 15 % to 90 %, non-condensing, but not requiring a water vapour partial pressure ≥ 50 hPa; and an atmospheric pressure range of 700 hPa to 1060 hPa.	

Transport & Storage Conditions	-25 °C to 70 °C; 10 % to 90 % RH
Altitudes	≤ 3000 m
Degree of Protection Against Ingress	IP21

## 11.2 EMC INFORMATION



**WARNING:** Use of this equipment adjacent to or stacked with other equipment should be avoided because it could result in improper operation. If such use is necessary, this equipment and the other equipment should be observed to verify that they are operating normally.



**WARNING:** Use of accessories, transducers, and cables other than those specified or provided by the manufacturer of this equipment could result in increased electromagnetic emissions or decreased electromagnetic immunity of this equipment and result in improper operation.

Description	Cable Length
Power Cable (non-shielding)	5 M



**WARNING:** Portable RF communications equipment (including peripherals such as antenna cables and external antennas) should be used no closer than 30 cm (12 inches) to any part of this device, including cables specified by the manufacturer. Otherwise, degradation of the performance of this equipment could result.

Manufacturer's declaration-electromagnetic emissions		
The <u>device(s)</u> is intended for use in the electromagnetic environment (for home and professional healthcare) specified below. The customer or the user of the <u>device(s)</u> should assure that it is used in such an environment.		
Emission test	Compliance	Electromagnetic environment-guidance (for home and professional healthcare environment)
RF emissions CISPR 11	Group 1	The <u>device(s)</u> uses RF energy only for its internal function. Therefore, its RF emissions are very low and are not likely to cause any interference in nearby electronic equipment.
RF emissions CISPR 11	Class B	The <u>device(s)</u> is suitable for use in all establishments, including domestic establishments and those directly connected to the public low-voltage power supply network that supplies buildings used for domestic purposes.
Harmonic emissions IEC 61000-3-2	Not applicable	
Voltage fluctuations /flicker emissions IEC 61000-3-3	Not applicable	

**Manufacturer's declaration-electromagnetic immunity**

The device(s) is intended for use in the electromagnetic environment (for home and professional healthcare) specified below.

The customer or the user of the device(s) should assure that it is used in such an environment.

<b>Immunity test</b>	<b>IEC 60601 test level</b>	<b>Compliance level</b>	<b>Electromagnetic environment-guidance (for home and professional healthcare environment)</b>
Electrostatic discharge(ESD) IEC 61000-4-2	Contact: ±8 kV Air ±2 kV, ±4 kV, ±8 kV, ±15 kV	Contact: ±8 kV Air ±2 kV, ±4 kV, ±8 kV, ±15 kV	Floors should be wood, concrete or ceramic tile. If floors are covered with synthetic material, the relative humidity should be at least 30%
Electrical fast transient/burst IEC 61000-4-4	± 2kV for power supply lines ± 1kV for input/output lines	± 2kV for power supply lines Not applicable	Mains power quality should be that of a typical home and professional healthcare environment.
Surge IEC 61000-4-5	± 0.5kV, ±1kV line(s) to line(s) ± 0.5kV, ±1kV, ± 2kV line(s) to earth	± 0.5kV, ±1kV line(s) to line(s) ± 0.5kV, ±1kV, ± 2kV line(s) to earth	Mains power quality should be that of a typical home and professional healthcare environment.
Voltage Dips, short interruptions and voltage variations on power supply input lines IEC 61000-4-11	Voltage dips: 0 % $U_T$ ; 0,5 cycle 0 % $U_T$ ; 1 cycle 70 % $U_T$ ; 25/30 cycles  Voltage interruptions: 0 % $U_T$ ; 250/300 cycle	Voltage dips: 0 % $U_T$ ; 0,5 cycle 0 % $U_T$ ; 1 cycle 70 % $U_T$ ; 30 cycles  Voltage interruptions: 0 % $U_T$ ; 300 cycle	Mains power quality should be that of a typical home and professional healthcare environment. If the user of the <u>device(s)</u> requires continued operation during power mains interruptions, it is recommended that the <u>device(s)</u> be powered from an uninterruptible power supply or a battery.
Power frequency(50, 60 Hz) magnetic field IEC 61000-4-8	30 A/m 50 Hz or 60 Hz	30 A/m 60 Hz	The <u>device(s)</u> power frequency magnetic fields should be at levels characteristic of a typical location in a typical home and professional healthcare environment.

NOTE  $U_T$  is the a.c. mains voltage prior to application of the test level.





<b>Recommended separation distance between portable and mobile RF communications equipment and the <u>device(s)</u></b>			
The <u>device(s)</u> is intended for use in an electromagnetic environment (for home and professional healthcare) in which radiated RF disturbances are controlled. The customer or the user of the <u>device(s)</u> can help prevent electromagnetic interference by maintaining a minimum distance between portable and mobile RF communications equipment (transmitters) and the <u>device(s)</u> as recommended below, according to the maximum output power of the communications equipment.			
Rated maximum output power of transmitter  W	Separation distance according to frequency of transmitter  m		
	150 kHz to 80 MHz  $d = 1,2\sqrt{P}$	80 MHz to 800 MHz  $d = 1,2\sqrt{P}$	800 MHz to 2,7 GHz  $d = 2,3\sqrt{P}$
0,01	0,12	0,12	0,23
0,1	0,38	0,38	0,73
1	1,2	1,2	2,3
10	3,8	3,8	7,3
100	12	12	23
<p>For transmitters rated at a maximum output power not listed above, the recommended separation distance <math>d</math> in meters (m) can be estimated using the equation applicable to the frequency of the transmitter, where <math>p</math> is the maximum output power rating of the transmitter in watts (W) according to the transmitter manufacturer.</p> <p>NOTE1 At 80 MHz and 800 MHz, the separation distance for the higher frequency range applies.</p> <p>NOTE2 These guidelines may not apply in all situations. Electromagnetic propagation is affected by absorption and reflection from structures, objects and people.</p>			

## Manufacturer's declaration-electromagnetic immunity

### Test specifications for ENCLOSURE PORT IMMUNITY to RF wireless communications equipment

The device(s) is intended for use in the electromagnetic environment (for home and professional healthcare) specified below.

The customer or the user of the device(s) should assure that it is used in such an environment.

Test frequency (MHz)	Band <sup>a)</sup> (MHz)	Service <sup>a)</sup>	Modulation <sup>b)</sup>	Maximum power (W)	Distance (m)	IMMUNITY TEST LEVEL (V/m)	Compliance LEVEL (V/m) (for home and professional healthcare)
385	380 – 390	TETRA 400	Pulse modulation b) 18 Hz	1,8	0,3	27	27
450	430 – 470	GMRS 460, FRS 460	FM c) ±5 kHz deviation 1 kHz sine	2	0,3	28	28
710	704 – 787	LTE Band 13, 17	Pulse modulation b) 217 Hz	0,2	0,3	9	9
745							
780							
810	800 – 960	GSM 800/900, TETRA 800, iDEN 820, CDMA 850, LTE Band 5	Pulse modulation b) 18 Hz	2	0,3	28	28
870							
930							
1 720	1 700 – 1 990	GSM 1800; CDMA 1900; GSM 1900; DECT; LTE Band 1, 3, 4, 25; UMTS	Pulse modulation b) 217 Hz	2	0,3	28	28
1 845							
1 970							
2 450	2 400 – 2 570	Bluetooth, WLAN, 802.11 b/g/n, RFID 2450, LTE Band 7	Pulse modulation b) 217 Hz	2	0,3	28	28
5 240	5 100 – 5 800	WLAN 802.11 a/n	Pulse modulation b) 217 Hz	0,2	0,3	9	9
5 500							
5 785							

**NOTE** If necessary to achieve the IMMUNITY TEST LEVEL, the distance between the transmitting antenna and the ME EQUIPMENT or ME SYSTEM may be reduced to 1 m. The 1 m test distance is permitted by IEC 61000-4-3.

- a) For some services, only the uplink frequencies are included.  
 b) The carrier shall be modulated using a 50 % duty cycle square wave signal.  
 c) As an alternative to FM modulation, 50 % pulse modulation at 18 Hz may be used because while it does not represent actual modulation, it would be worst case.

